

XGZP132 PRESSURE SENSOR

FEATURES

- Range: 0kPa ~ 100kPa…2000kPa
- MEMS technology, Solid-state reliability
- Small volume
- COB Package
- For non-corrosive gas or air and liquid
- Working temp.: -30°C ~ +125°C (-22°F ~ +257°F)
- Absolute Pressure Type
- Easy to use and embed in OEM equipment

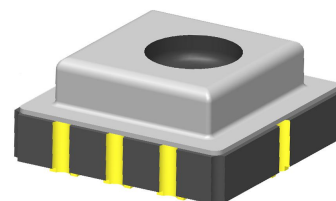

APPLICATIONS

- Air pump, Inflator pump, White goods(e.g.washer), Heating, Ventilation, Air conditioning, Fire extinguisher, Filter detection, Industrial controls.
- Medical gas control system, Hospital beds, Massage device, Oil pressure, Engine control/manifold absolute pressure (MAP), Green gas(LPG and CNG) control and measurement, Tire pressure meter.
- Weather station and weather reporting device barometers, Altimeter, Drone, Sport and leisure equipment, Vacuum measurement, pneumatic device, GPS, Navigation.

INTRODUCTION

XGZP132 is a surface mounting pressure sensor based on CFSensor silicon-glass based piezoresistive pressure sensor die. The sensor die is bonded on a substrate with a metal cap and packaged with a small volume. The small size and high reliability of on-chip integration make this sensor a simple and economical choice for high volume application in a variety of industries. With small COB package, XGZP132 is easy for users to install on board.

With good repeatability, linearity, stability and sensibility, XGZP132 is very facile for users to calibrate output & thermal drift and make temperature compensation by using exterior operational amplifier or integrated circuit.(For calibrated sensor if required, please refer to CFSensor pressure module series)

The XGZP132 pressure sensor is intended for use with non-corrosive gas or air and liquid, It is highly prohibited to choke the side of pressure diaphragm during actual application.

Electronic Performance

- Power Supply: $\leq 15\text{Vdc}$ or $\leq 3.0\text{mAdc}$
- Input Impedance : $4\text{k}\Omega \sim 6\text{k}\Omega$
- Output Impedance : $4\text{k}\Omega \sim 6\text{k}\Omega$
- Insulation Resistor: $100\text{M}\Omega, 100\text{VDC}$
- Over Pressure: 1.5X Rated Pressure

Construction

- Sensing Die: Silicon
- Die Mounting Glue: Silicone Gel
- Leading wire: Gold Wire
- Package Housing: Ceramic Board&Metal cover
- Pin: Golden Plated
- Net Weight: Approx.0.5g

Environment Condition

- Orientation: Deviate 90° from any direction, zero change $\leq 0.05\%FS$
- Shock: No change at 10gRMS , (20 ~ 2000)Hz condition
- Impact: 100g, 11ms
- Medium Compatibility: air or gas compatible with FR4, silicone, silicone glue, epoxy glue and metal(gold, aluminum and silver)

Test Condition

- Medium: Gas(Clean air and Non-corrosive gas or Liquid)
- Medium Temp: $(25\pm 1)^\circ\text{C}/(77\pm 1.8)^\circ\text{F}$
- Environment Temp.: $(25\pm 1)^\circ\text{C}/(77\pm 1.8)^\circ\text{F}$
- Shock: 0.1g (1m/s²) Max
- Humidity: (50%±10%) RH
- Power Supply: (5 ± 0.005) VDC

SPECIFICATIONS

Specifications	Min.	Typ.	Max	Unit
Pressure Range ^①	100,700,2000			kPa
	10,70,200			bar
Working Temperature	-30/-22		+125/257	°C/°F
Storage Temperature	-40/-40		+140/284	°C/°F
Bridge Resistance	4	5	6	kΩ
Offset/Zero Output	-20		+20	mV
FS Output	60		120	mV
Temp. Coefficient of Resistance ^③	2000	2600	3200	ppm/°C
TCO(Temp. Coefficient of Offset) ^③	-0.05	±0.02	0.05	%FS/°C ^②
TCS(Temp. Coefficient of Span) ^③	-0.26	-0.23	-0.2	%FS/°C ^②
Linearity ^⑤	-0.3		0.3	%FS
Hysteresis	-0.3		0.3	%FS
Repeatability	-0.3		0.3	%FS
Long-term Stability	-1.0		1.0	%FS
Response Time		2		mSec.

Note:

- ①The pressure range is on base of Absolute vaccum..
- ②Excitated by constant voltage
- ③Temperature coefficient is measured from 0°C to 60°C.(32°F ~ 140°F)
- ④Defined as best fit straight line

Unless otherwise specified,measurements were taken on base of above testing condition.

PIN CONNECTION&DEFINITION

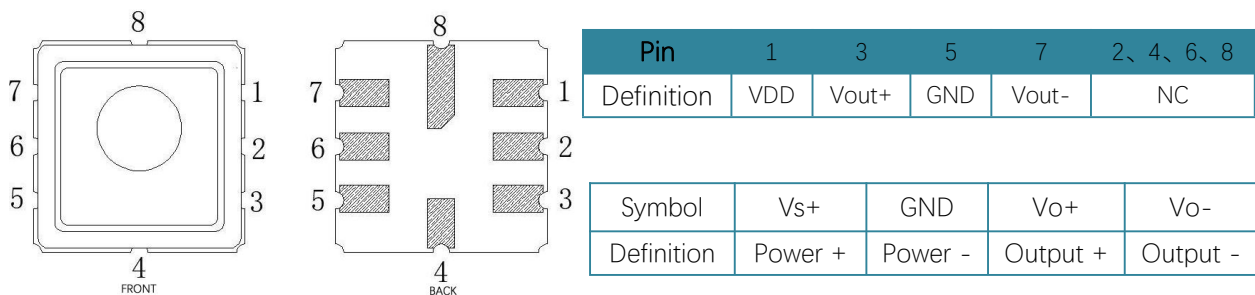

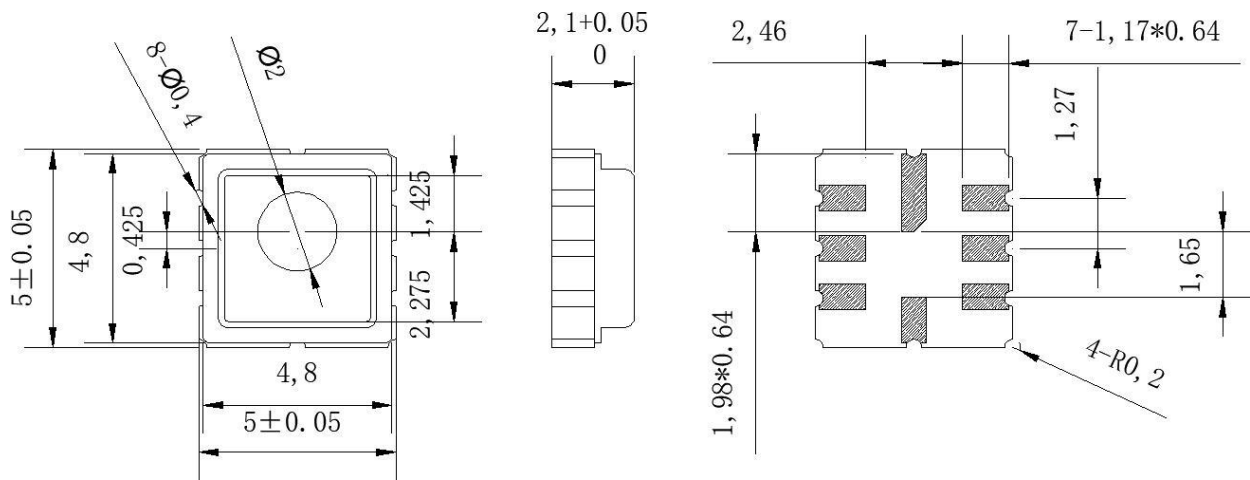
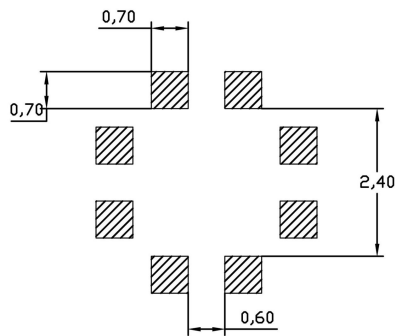
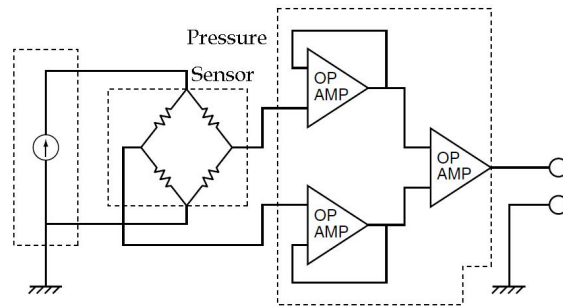
DIMENSION (Unit:mm)

FOOTPRINT(REFERENCE)

APPLICATION CIRCUIT

ORDER GUIDE

XGZP132	Piezo-resistive Pressure Sensor		
	Code	Range	$100\text{kPa} = 0.1\text{mKp} = 750\text{mmHg} = 10\text{MH}_2\text{O} \approx 1\text{bar} \approx 14.5\text{PSI}$
	101	$0 \sim 100\text{kPa}$	
	701	$0 \sim 700\text{kPa}$	
	202	$0 \sim 2000\text{kPa}$	
XGZP132	202	the whole spec.	

RECOMMENDED PRODUCTS

Another sensors at right place is calibrated with amplified analog output signal or digital output(IIC interface).

It temperature compensted with customized pressure range and input/output parameter, which can be applied in project directly.

Please contact us more information information.

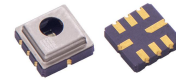

XGZP6826

OVERALL NOTES

Unless otherwise specified, following notes are general attention or presentation for all products from CFsensor.

Mounting

The following steps is for transmitting the air pressure to sensor after sensor soldering on PCB.

- ▼ For some sensors that come with inlet tube, select the flexiable pipe to suit the pressure inlet that is firm enough to prevent the pressure leaks.
- ▼ Atmosphere hole (for Gauge type sensors) and Inlet pipe/hole can't be blocked with gel or glue etc..
- ▼ Avoiding excessive external force operation

Soldering

Due to its small size, the thermal capacity of the pressure sensor is low. Therefore, take steps to minimize the effects of external heat. Damage and changes to characteristics may occur due to heat deformation. Use a non-corrosive resin type of flux. Since the pressure sensor is exposed to the atmosphere, do not allow flux to enter inside.

▼ Manual soldering

- Raise the temperature of the soldering tip between 260 and 300°C/500 and 572°F (30 W) and solder within 5 seconds.
- The sensor output may vary if the load is applied on the terminal during soldering.
- Keep the soldering tip clean.

▼ DIP soldering (DIP Terminal)

- Keep the temperature of the DIP solder tank below 260°C/500 and solder within 5 seconds.
- To avoid heat deformation, do not perform DIP soldering when mounting on the PCB which has a small thermal capacity.

▼ Reflow soldering (SMD Terminal)

- The recommended reflow temperature profile conditions are given below.

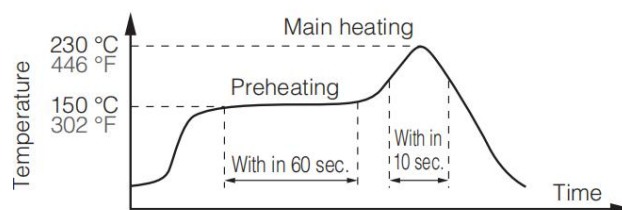

- Self alignment may not always work as expected, therefore, please carefully note the position of the terminals and pattern.
- The temperature of the profile is assumed to be a value measured with the PCB of the terminal neighborhood.
- Please evaluate solderbility under the actual mounting conditions since welding and deformation of the pressure inlet port may occur due to heat stress depending on equipments or conditions.

▼ Rework soldering

- Complete rework at a time.
- Use a flattened soldering tip when performing rework on the solder bridge. Do not add the flux.
- Keep the soldering tip below the temperature described in the specifications.

- ▼ Avoid drop and rough handling as excessive force may deform the terminal and damage soldering characteristics.
- ▼ Keep the circuit board warpage within 0.05 mm of the full width of the sensor.
- ▼ After soldering, do not apply stress on the soldered part when cutting or bending the circuit board.
- ▼ Prevent human hands or metal pieces from contacting with the sensor terminal. Such contact may cause anomalous outlets as the terminal is exposed to the atmosphere.
- ▼ After soldering, prevent chemical agents from adhering to the sensor when applying coating to avoid insulation deterioration of the circuit board.

Connecting

- ▼ Correctly wire as in the connection diagram. Reverse connection may damage the product and degrade the performance.
- ▼ Do not use idle terminals(N/C) to prevent damages to the sensor.

Cleaning

- ▼ Since the pressure sensor is exposed to the atmosphere, do not allow cleaning fluid to enter inside from atmosphere hole (for Gauge type sensors) and inlet pipe.
- ▼ Avoid ultrasonic cleaning since this may cause breaks or disconnections in the wiring.

Environment

- ▼ Please avoid using or storing the pressure sensor in a place exposed to corrosive gases (such as the gases given off by organic solvents, sulfurous acid gas, hydrogen sulfides, etc.) which will adversely affect the performance of the pressure sensor chip.
- ▼ Since this pressure sensor itself does not have a water-proof construction(even available media can be liquid), please do not use the sensor in a location where it may be sprayed with water, etc.
- ▼ Avoid using the pressure sensors in an environment where condensation may form. Furthermore, its output may fluctuate if any moisture adhering to it freezes.
- ▼ The pressure sensor is constructed in such a way that its output will fluctuate when it is exposed to light. Especially when pressure is to be applied by means of a transparent tube, take steps to prevent the pressure sensor chip from being exposed to light.
- ▼ Avoid using pressure sensor where it will be susceptible to ultrasonic or other high-frequency vibration.
- ▼ Please keep the sensors sealed using static shielding bags on storage. The PINs of sensor(if have) may be black by oxidation under atmosphere environment if the materials include the oxidizable material, although it wouldn't affect the sensor performance.

More Precautions

- ▼ That using the wrong pressure range or mounting method may result in accidents.
- ▼ The only direct pressure medium you can use is non-corrosive gas or air as illuminated above(Note: some sensors are compatible with liquid media). The use of other media, in particular, corrosive gases and liquid (organic solvent based, sulfurous acid based, and hydrogen sulfide based, etc.) or contains foreign substances will cause malfunction and damage. Please do not use them and check with CFSensor.
- ▼ The pressure sensor is positioned inside the pressure inlet. Never poke wires or other foreign matter through the pressure inlet since they may damage the sensor or block the inlet. Avoid use when the atmospheric pressure inlet(only for Gauge type pressure sensor) is blocked.
- ▼ Use an operating pressure which is within the rated pressure range. Using a pressure beyond this range may cause damage.

▼ Since static charge can damage the pressure sensor, bear in mind the following handling precautions.

⊙ When storing the pressure sensor, use a conductive material to short the pins or wrap the entire sensor in aluminum foil. Common plastic containers should not be used to store or transport the sensor since they readily become charged.

⊙ When using the pressure sensor, all the charged articles on the bench surface and the work personnel should be grounded so that any ambient static will be safely discharged.

▼ Based on the pressure involved, give due consideration to the securing of the pressure sensor.

【 SAFETY NOTES 】

Using these sensors products may malfunction due to external interference and surges, therefore, please confirm the performance and quality in actual use. Just in case, please make a safety design on the device (fuse, circuit breaker, such as the installation of protection circuits, multiple devices, etc.), so it would not harm life, body, property, etc even a malfunction occurs. To prevent injuries and accidents, please be sure to observe the following items:

- The driving current and voltage should be used below the rated value.
- Please follow the terminal connection diagram for wiring. Especially for the reverse connection of the power supply, it will cause an accident due to circuit damage such as heat, smoke, fire, etc.
- In order to ensure safety, especially for important uses, please be sure to consider double safety circuit configuration.
- Do not apply pressure above the maximum applied pressure. In addition, please be careful not to mix foreign matter into the pressure medium. Otherwise, the sensor will be discarded, or the media will blow out and cause an accident.
- Be careful when fixing the product and connecting the pressure inlet. Otherwise, accidents may occur due to sensor scattering and the blowing out of the media.
- If the sensor come with sharp PIN, please be careful not to hurt your body when using it.

【 WARRANTY 】

The information in this sheet has been carefully reviewed and is believed to be accurate; however, no responsibility is assumed for inaccuracies. Furthermore, this information does not convey to the purchaser of such devices any license under the patent rights to the manufacturer. CFSensor reserves the right to make changes without further notice to any product herein. CFSensor makes no warranty, representation or guarantee regarding the suitability of its product for any particular purpose, nor does CFSensor assume any liability arising out of the application or use of any product or circuit and specifically disclaims any and all liability, including without limitation consequential or incidental damages. Typical parameters can and do vary in different applications. All operating parameters must be validated for each customer application by customer's technical experts. CFSensor does not convey any license under its patent rights nor the rights of others.

【 CONTACT 】

CFSensor

14-15F/4Bldg High-Tech Park High-Tech Area Wuhu P.R.C.241000

Tel/Fax: +86 18226771331 Email: INFO@CFSensor.com

North America || Europe || Southeast Asia || Middle East || Latin America