

XGZP6857A PRESSURE SENSOR MODULE

FEATURES

- Wide Ranges: -100kPa~0kPa~1000kPa(show in [Routine Pressure Range](#))
- Optional 5V or 3.3V Power Supply
- Gage (Positive&Vacuum) Type
- For Non-corrosive Gas or Air
- Calibrated Amplified Analog Signal(Refer to XGZP6857D for I2C interface)
- Temp. Compensated: 0°C ~ +60°C(32°F ~ +140°F)
- Easy-to-use, Low Cost.

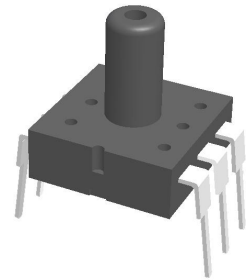

✓ **RoHS**

APPLICATIONS

- For medical and healthy equipment, e.g. Blood pressure test and monitor, Patient Monitoring, Infusion and Syringe Pumps, Anesthesia machines, Respirators and Ventilators, NPWT, DVT, Catheter, COPD Treatment, Kidney dialysis, Cupping& Cosmetology, Hospital beds, Massage device etc.
- For white goods and consumer electronics, e.g. Refrigerator, Printer, Humidifier, Washer/Dryer, Coffee machine, Dust collector or Cleaner, Robotic, Sport equipment etc.
- For more fields, e.g. Air pump, Process control, Pressure switching, HVAC and pneumatic device, Air flow monitor, Automation, Automotive application etc.

INTRODUCTION

XGZP6857A is a perfect silicon pressure sensor module offering a ratiometric analog interface for reading pressure over the specified full scale pressure span.

The XGZP6857A incorporates a silicon piezoresistive pressure sensor die and an interior Application Specific Integrated Circuit(ASIC) in a DIP6 package

The XGZP6857A is fully calibrated and temperature compensated for specified span, so XGZP6857A pressure sensor module satisfy the perfect accuracy, which is designed for a wide range of applications in medical care&health, home appliances, consumer electronic, industry, automotive, IoT and other pneumatic devices etc by utilizing a microcontroller or microprocessor with A/D inputs.

XGZP6857A pressure sensor module is for high volume application at an affordable cost and perfect performance.

Customized calibration parameter (pressure range, working voltage, output etc.) are available.

PERFORMANCE PARAMETER

Unless otherwise specified, measurements were taken with a a temperature of $25 \pm 1^\circ\text{C}$ and humidity ranging from 25 % ~ 85%RH(supply voltage:5 Vdc or 3.3V or 3.0V)

Item	Data	Unit
Available Pressure Range ¹	<u>-100...0...1000</u>	kPa
Power Supply ²	5/3.3/3.0	Vdc
Max. Excitation Current	3	mA
Output Range ³	0.5 ~ 4.5/0.2 ~ 2.7	Vdc
Total Accuracy ⁴	10kPa < Pressure ≤ 200kPa	±2
	200kPa ≤ Pressure ≤ 10kPa	±2.5
Long Term Stability ⁵	±1	%Span
Over Pressure ⁶	2X	Rated
Burst Pressure ⁷	3X	Rated
Compensation Temp. ⁸	0 ~ 60/32 ~ 140	°C/°F
Operating Temp. ⁹	-20 ~ 100/-4 ~ 212	°C/°F
Storage Temp.	-30 ~ 125/-22 ~ 257	°C/°F
Response Time ¹⁰	2.5	mS

1 **Pressure Range(Operating pressure)**: The available pressure range including various span, not a specific pressure range.

2 **Power Supply**:

- 2.1. Acceptable voltage deviation is within 5% of the specified voltage(e.g. 4.75~5.25V @5V working voltage)
- 2.2. Optional working voltage can be 2V to 5.5V with ratiometric or specific voltage output (note in purchase order).

3 **Output Range**:

- 3.1. Output Range is defined as the output voltage from minimum rated pressure to maximum rated pressure, including Offset(Zero output) : it is defined as the output voltage at the minimum rated pressure;
Full Scale Output (FSO): it is defined as the output voltage at the maximum or full rated pressure;
Full Scale Span (FSS): it is the algebraic difference between the output voltage at FSO and Offset.
- 3.2. Output range can be customized under working voltage, e.g 0.2 ~ 4.7@5V;0.2 ~ 4.8@5V;0.12 ~ 2.8@3V etc..
- 3.3. Output value is nominal values without the count of Accuracy deviation.

4 **Total Accuracy**: The max. deviation in output from ideal transfer function at any pressure or temperature over the specified ranges, units are in percent of full scale span (%FSS), which mainly consists of: Offset and Span Shift;Linearity(Non-linearity); Repeatability; Pressure Hsteresis ; TcOffset and TcSpan.

4.1. The accuracy in table is the typical output accuracy. The accuracy is not identical accroding to different specified pressure range. Contact factory for more information or for higher accuracy requirement(e.g ±1%Span) if need.

4.2 Non-linearity(Linearity): the deviation of measured output from "Best Straight Line" through three points (Offset pressure, FS pressure and ½ FS pressure)at constant temperature.

4.3 Repeatability: the deviation of measured output when the same pressure is applied continuously, with pressure approaching from the same direction within the specified operating pressure range,under the same operating conditions.

4.4 Pressure Hysteresis: the deviation of measured output at any pressure within the specified range, when this pressure is applied continuously, with pressure approaching from opposite directions within the specified operating pressure range, under the same operating conditions.

4.5 TcOffset (TCO:Temp. Coefficient of Offset): the deviation of measured output with minimum rated pressure applied, over the temperature range of 0° to 60°C, relative to 25°C.

4.6 TcSpan (TCS:Temp. Coefficient of Span): the deviation of measured output over the temperature range of 0° to 60°C, relative to 25°C.

5. **Long Term Stability**: the sensor's output deviation when subjected to 1000 hours pressure test.

6. **Over Pressure** (Proof pressure): the maximum pressure which may be applied without causing durable shifts of the electrical parameters of the sensing element and remain the specification once pressure is returned to the operating pressure range.

7. **Burst Pressure**: the maximum pressure which may be applied without causing damage to the sensing die or leaks; The sensor should not be expected to recover function after exposure to any pressure beyond the burst pressure.

8. **Compensated Temperature**: the temperature range over which the sensor have an output proportional to pressure within the specified performance limits.

9. **Operating Temperature** (or Ambient Temperature): the temperature range over which the sensor have an output proportional to pressure but may not remain within the specified performance limits.

10. **Response Time**: it is defined as the time for the incremental change in the output from 10% to 90% of full-scale pressure.

ELECTRICAL CHARACTERISTICS(Interior ASIC)

Parameter	Min.	Typ.	Max.	Unit	Notes
Power Supply			5.5	V	
Working Current		100		nA	
Filter Capacitor		100		nF	
PSRR		60		dB	
Output Current Load			5	mA	
Input Common Mode Rejection Ratio	80	110		dB	
Short-circuit Current Limit	15	20	25	mA	
Upper limit Clamping Voltage	3/4		1	VDD	
Lower limit Clamping Voltage	0		1/4	VDD	

BLOCK DIAGRAM

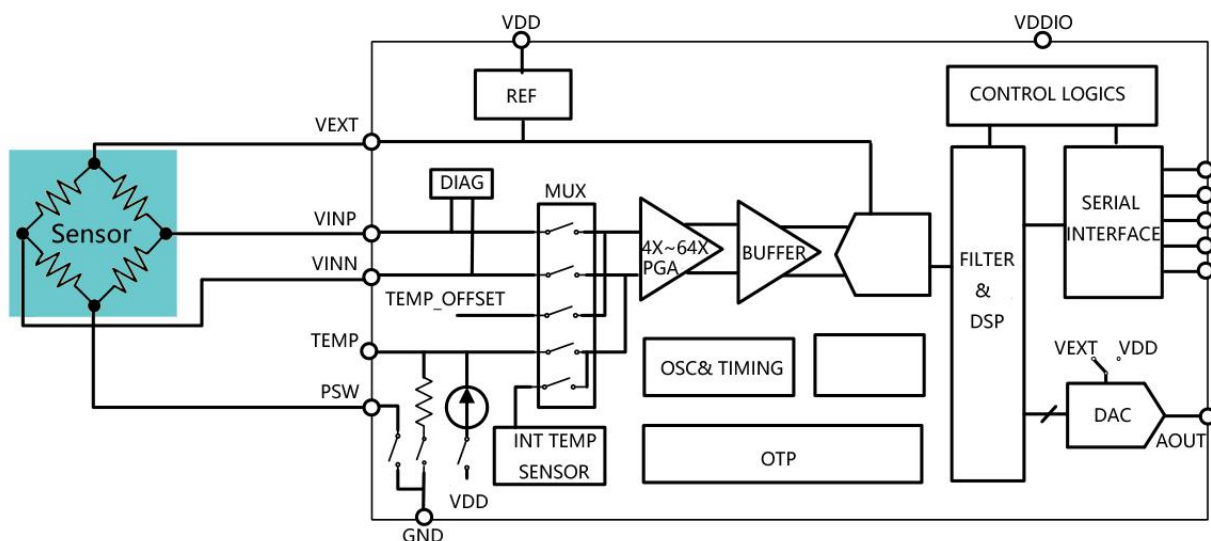

DIMENSION (Unit:mm)

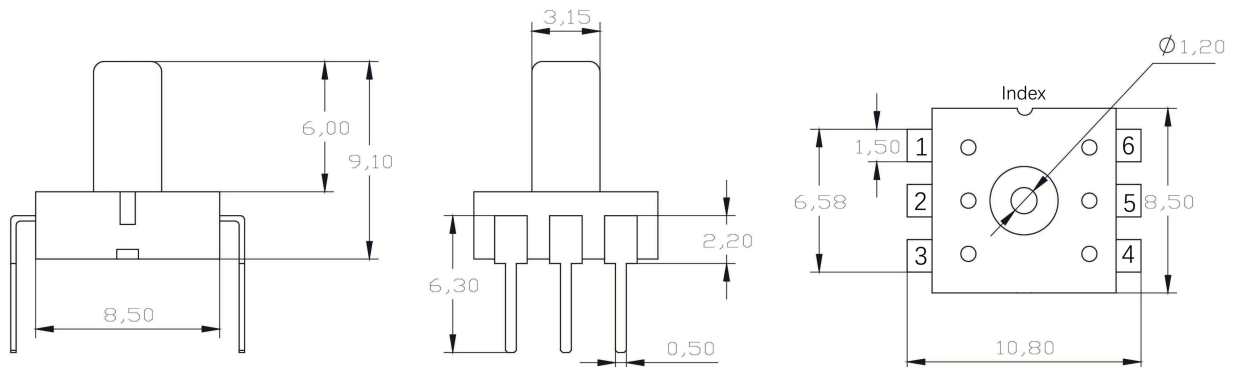

ELECTRIC CONNECTION

1	2	3	4	5	6
N/C	VDD	OUT	N/C	N/C	GND

NAME	FUNCTION
N/C	Do not connect to external circuitry or ground
VDD	Voltage supply
OUT	Output voltage
GND	Ground

CIRCUIT DIAGRAM

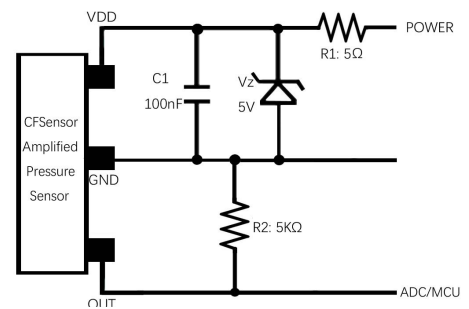

Note: Diagram state schematic connection only;
Check Pin allocation in Dimension drawing.

CROSS SECTION

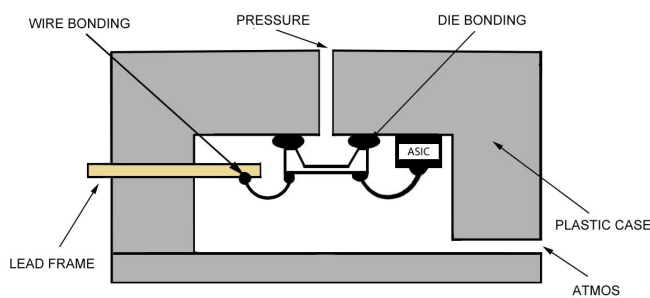

FOOTPRINT(REFERENCE)

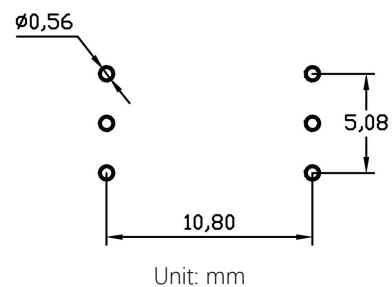

Notes:

1. Implement ESD protection during whole soldering and assembly process.
2. Overload voltage(max.6.5Vdc) or current(max.5mA) may burn the ASIC and cause the sensor fail throughly.
3. More details about soldering and storage etc., refer to [Overall notes](#).

ORDER GUIDE

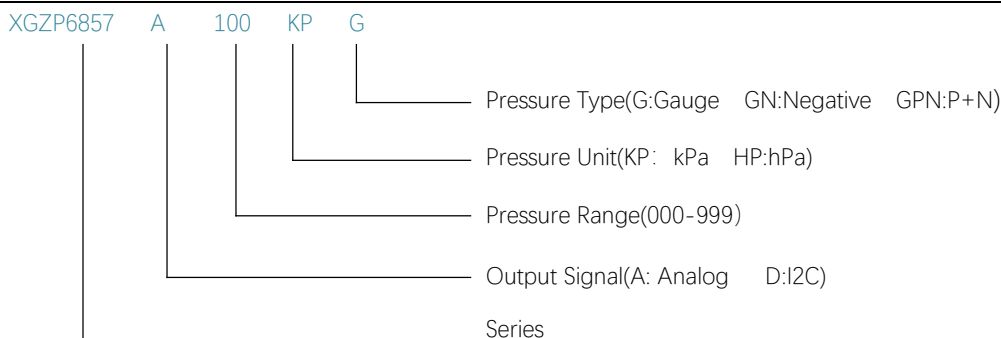

Note: 1. Voltage 5Vdc as default value, add 33(or 30) behind model signify 3.3V(or 3.0V) power supply, e.g. : XGZP6857A040KPG33.

2. Custom requirement, please comment herewith Part number(e.g custom pressure range etc.), or consult CFSensor

ROUTINE PRESSURE RANGE

Notes: 1. Unit conversion: 1000hPa=1000mbar≈750mmHg≈100kPa≈14.5PSI≈10mH₂O≈1bar=0.1MPa;

2. Available for more custom pressure range e.g. -7 ~ 7kPa, , 0-700kPa etc..

Pressure Range (kPa)	Pressure Range (by other units)	Part Number
0 ~ 2.5	0 ~ 25mbar / 0 ~ 250mmH ₂ O	XGZP6857A025HPG
0 ~ 5	0 ~ 50mbar / 0 ~ 500mmH ₂ O	XGZP6857A005KPG
0 ~ 10	0 ~ 100mbar / 0 ~ 75mmHg	XGZP6857A010KPG
0 ~ 20	0 ~ 200mbar / 0 ~ 150mmHg	XGZP6857A020KPG
0 ~ 40	0 ~ 400mbar / 0 ~ 300mmHg	XGZP6857A040KPG
0 ~ 100	0 ~ 1bar / 0 ~ 14.5PSI	XGZP6857A100KPG
0 ~ 200	0 ~ 2bar / 0 ~ 29PSI	XGZP6857A200KPG
0 ~ 700	0 ~ 7bar / 0 ~ 100PSI	XGZP6857A700KPG
0 ~ 1000	0 ~ 10bar / 0 ~ 1MPa	XGZP6857A001MPG
-100 ~ 0	-1 ~ 0bar / -14.5 ~ 0PSI	XGZP6857A100KPGN
-30 ~ 0	-300 ~ 0mbar / -4.35 ~ 0PSI	XGZP6857A030KPGN
-20 ~ 0	-200 ~ 0mbar / -2.9 ~ 0PSI	XGZP6857A020KPGN
-1 ~ 1	-10 ~ 10mbar / -100 ~ 100mmH ₂ O	XGZP6857A001KPGPN
-2.5 ~ 2.5	-25 ~ 25mbar / -250 ~ 250mmH ₂ O	XGZP6857A025HPGPN
-5 ~ 5	-50 ~ 50mbar / -500 ~ 500mmH ₂ O	XGZP6857A005KPGPN
-40 ~ 40	-400 ~ 400mbar / -300 ~ 300mmHg	XGZP6857A040KPGPN
-100 ~ 100	-1 ~ 1bar / -14.5 ~ 14.5PSI	XGZP6857A100KPGPN
-100 ~ 200	-1 ~ 2bar / -14.5 ~ 29PSI	XGZP6857A200KPGPN

Other higher pressure range or custom pressure span, consult CFSensor

XGZP6857A OUTPUT CURVE

Note: Output can be calibrated to reverse line with pressure, e.g. -100 ~ 0kPa correspond with 4.5 ~ 0.5V;

Negative Pressure

Pressure value VS Output value

Model	100KPGN	020KPGN	010KPGN
Output(V)	Pressure (kPa)		
0.5	-100	-20	-10
1.5	-75	-15	-7.5
2.5	-50	-10	-5
3.5	-25	-5	-2.5
4.5	0	0	0

Curve(Output VS Pressure)

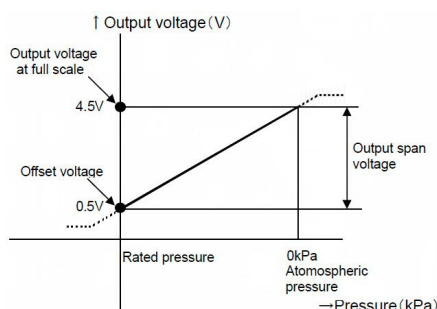

Pressure Conversion Formula

3.3V Power Supply: $Pressure = (output - 2.7) / K$
 5V Power Supply: $Pressure = (output - 4.5) / K$

K value VS Rated Pressure range		
Range (kPa)	3.3 (V)	5 (V)
-10 ~ 0	0.25	0.4
-20 ~ 0	0.125	0.2
-40 ~ 0	0.0625	0.1
-100 ~ 0	0.025	0.04

Negative Pressure to Positive Pressure

Pressure value VS Output value

Model	005KPGPN	040KPGPN	100KPGPN
Output(V)	Pressure (kPa)		
0.5	-5	-40	-100
1.5	-2.5	-20	-50
2.5	0	0	-0
3.5	2.5	20	50
4.5	5	40	100

Curve(Output VS Pressure)

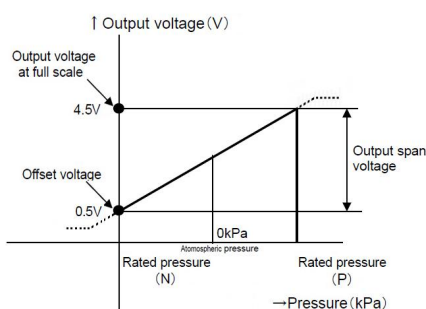

Pressure Conversion Formula

3.3V Power Supply: $Pressure = (output - 1.45) / K$
 5V Power Supply: $Pressure = (output - 2.5) / K$

K value VS Rated Pressure range		
Range (kPa)	3.3 (V)	5 (V)
-10 ~ 10	0.125	0.2
-40 ~ 40	0.03125	0.05
-100 ~ 100	0.0125	0.02

NOTE: -100KPA AS MAX NEGATIVE

Positive Pressure

Pressure value VS Output value

Model	001KPG	025HPG
Output (V)	Pressure (kPa)	
0.5	0	0
1.5	0.25	0.625
2.5	0.5	1.25
3.5	0.75	1.875
4.5	1	2.5

Curve(Output VS Pressure)

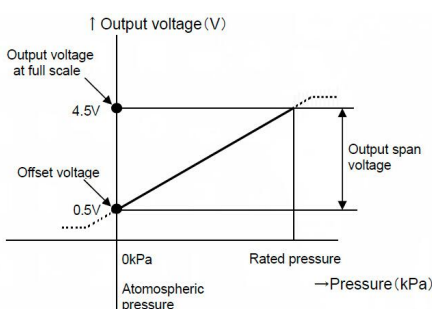

Pressure Conversion Formula

3.3V Power Supply: $Pressure = (output - 0.2) / K$
 5V Power Supply: $Pressure = (output - 0.5) / K$

K value VS Rated Pressure range		
Range (kPa)	3.3 (V)	5 (V)
1	2.5	4.0
2.5	1	1.6
5	0.5	0.8
10	0.25	0.4
20	0.125	0.2
40	0.0625	0.1
100	0.025	0.04
200	0.0125	0.02

Model	005KPG	010KPG	020KPG	040KPG	060KPG	200KPG
Output	Pressure (kPa)					
0.5	0	0	0	0	0	0
1.5	1.25	2.5	5	10	25	50
2.5	2.5	5	10	20	50	100
3.5	3.75	7.5	15	30	75	150
3.5	5	10	20	40	100	200

PACKING INFORMATION

Plastic Tube(unit:mm)

Standard Quantity/Tube: 58 pcs

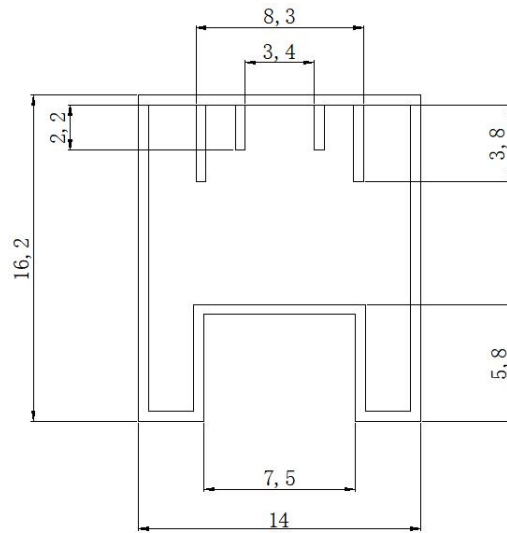

Side view

White Plug

Mark Direction

Blue Plug

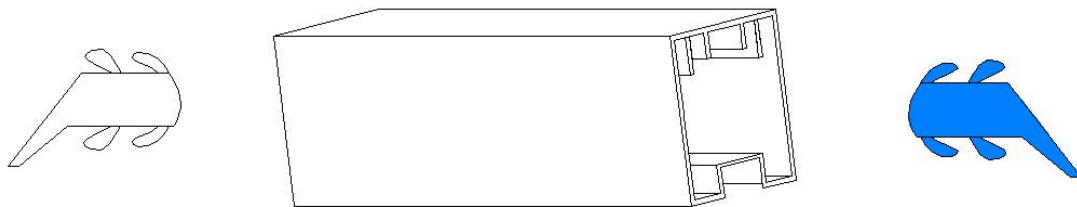

(520mm x 14mm x 16.2mm, 58PCS)

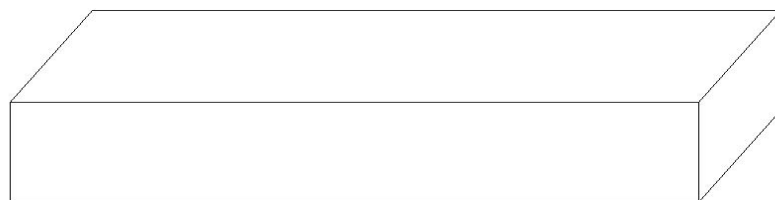
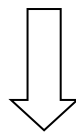

(CARTON: 530mm x 145mm x 53mm, 1740PCS)

Note: The packing size may be not quite same with above for other different quantity.

OVERALL NOTES

Unless otherwise specified, following notes are general attention or presentation for all products from CFSensor.

Mounting

The following steps is for transmitting the air pressure to sensor after sensor soldering on PCB.

- ▼ For some sensors that come with inlet tube, select the flexiable pipe to suit the pressure inlet that is firm enough to prevent the pressure leaks.
- ▼ Atmosphere hole (for Gauge type sensors) and Inlet pipe/hole can't be blocked with gel or glue etc..
- ▼ Avoiding excessive external force operation

Soldering

Due to its small size, the thermal capacity of the pressure sensor is low. Therefore, take steps to minimize the effects of external heat. Damage and changes to characteristics may occur due to heat deformation. Use a non-corrosive resin type of flux. Since the pressure sensor is exposed to the atmosphere, do not allow flux to enter inside.

- ▼ Manual soldering
 - ⊙ Raise the temperature of the soldering tip between 260 and 300°C/500 and 572°F (30 W) and solder within 5 seconds.
 - ⊙ The sensor output may vary if the load is applied on the terminal during soldering.
 - ⊙ Keep the soldering tip clean.
- ▼ DIP soldering (DIP Terminal)
 - ⊙ Keep the temperature of the DIP solder tank below 260°C/500 and solder within 5 seconds.
 - ⊙ To avoid heat deformation, do not perform DIP soldering when mounting on the PCB which has a small thermal capacity.
- ▼ Reflow soldering (SMD Terminal)
 - ⊙ The recommended reflow temperature profile conditions are given below.

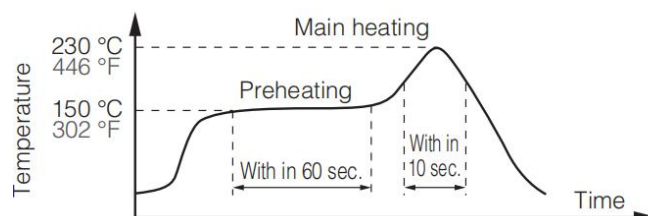

- ⊙ Self alignment may not always work as expected, therefore, please carefully note the position of the terminals and pattern.
- ⊙ The temperature of the profile is assumed to be a value measured with the printed circuit board of the terminal neighborhood.
- ⊙ Please evaluate solderability under the actual mounting conditions since welding and deformation of the pressure inlet port may occur due to heat stress depending on equipments or conditions.
- ▼ Rework soldering
 - ⊙ Complete rework at a time.
 - ⊙ Use a flattened soldering tip when performing rework on the solder bridge. Do not add the flux.
 - ⊙ Keep the soldering tip below the temperature described in the specifications.
- ▼ Avoid drop and rough handling as excessive force may deform the terminal and damage soldering characteristics.
- ▼ Keep the circuit board warpage within 0.05 mm of the full width of the sensor.
- ▼ After soldering, do not apply stress on the soldered part when cutting or bending the circuit board.
- ▼ Prevent human hands or metal pieces from contacting with the sensor terminal. Such contact may cause anomalous outlets as the terminal is exposed to the atmosphere.
- ▼ After soldering, prevent chemical agents from adhering to the sensor when applying coating to avoid insulation

deterioration of the circuit board.

Connecting

- ▼ Correctly wire as in the connection diagram. Reverse connection may damage the product and degrade the performance.
- ▼ Do not use idle terminals(N/C) to prevent damages to the sensor.

Cleaning

- ▼ Since the pressure sensor is exposed to the atmosphere, do not allow cleaning fluid to enter inside from atmosphere hole (for Gauge type sensors) and inlet pipe.
- ▼ Avoid ultrasonic cleaning since this may cause breaks or disconnections in the wiring.

Environment

- ▼ Please avoid using or storing the pressure sensor in a place exposed to corrosive gases (such as the gases given off by organic solvents, sulfurous acid gas, hydrogen sulfides, etc.) which will adversely affect the performance of the pressure sensor chip.
- ▼ Since this pressure sensor itself does not have a water-proof construction(even available media can be liquid), please do not use the sensor in a location where it may be sprayed with water, etc.
- ▼ Avoid using the pressure sensors in an environment where condensation may form. Furthermore, its output may fluctuate if any moisture adhering to it freezes.
- ▼ The pressure sensor is constructed in such a way that its output will fluctuate when it is exposed to light. Especially when pressure is to be applied by means of a transparent tube, take steps to prevent the pressure sensor chip from being exposed to light.
- ▼ Avoid using pressure sensor where it will be susceptible to ultrasonic or other high-frequency vibration.
- ▼ Please keep the sensors sealed using static shielding bags on storage. The PINs of sensor(if have) may be black by oxidation under atmosphere environment if the materials include the oxidizable material, although it wouldn't affect the sensor performance.

More Precautions

- ▼ That using the wrong pressure range or mounting method may result in accidents.
- ▼ The only direct pressure medium you can use is non-corrosive gas or air as illuminated above(Note: some sensors are compatible with liquid media). The use of other media, in particular, corrosive gases and liquid (organic solvent based, sulfurous acid based, and hydrogen sulfide based, etc.) or contains foreign substances will cause malfunction and damage. Please do not use them and check with CFSensor.
- ▼ The pressure sensor is positioned inside the pressure inlet. Never poke wires or other foreign matter through the pressure inlet since they may damage the sensor or block the inlet. Avoid use when the atmospheric pressure inlet(only for Gauge type pressure sensor) is blocked.
- ▼ Use an operating pressure which is within the rated pressure range. Using a pressure beyond this range may cause damage.
- ▼ Since static charge can damage the pressure sensor, bear in mind the following handling precautions.
 - When storing the pressure sensor, use a conductive material to short the pins or wrap the entire sensor in aluminum foil. Common plastic containers should not be used to store or transport the sensor since they readily become charged.
 - When using the pressure sensor, all the charged articles on the bench surface and the work personnel should be grounded so that any ambient static will be safely discharged.
- ▼ Based on the pressure involved, give due consideration to the securing of the pressure sensor.

【 SAFETY NOTES 】

Using these sensors products may malfunction due to external interference and surges, therefore, please confirm the performance and quality in actual use. Just in case, please make a safety design on the device (fuse, circuit breaker, such as the installation of protection circuits, multiple devices, etc.), so it would not harm life, body, property, etc even a malfunction occurs. To prevent injuries and accidents, please be sure to observe the following items:

- The driving current and voltage should be used below the rated value.
- Please follow the terminal connection diagram for wiring. Especially for the reverse connection of the power supply, it will cause an accident due to circuit damage such as heat, smoke, fire, etc.
- In order to ensure safety, especially for important uses, please be sure to consider double safety circuit configuration.
- Do not apply pressure above the maximum applied pressure. In addition, please be careful not to mix foreign matter into the pressure medium. Otherwise, the sensor will be discarded, or the media will blow out and cause an accident.
- Be careful when fixing the product and connecting the pressure inlet. Otherwise, accidents may occur due to sensor scattering and the blowing out of the media.
- If the sensor come with sharp PIN, please be careful not to hurt your body when using it.

【 WARRANTY 】

The information in this sheet has been carefully reviewed and is believed to be accurate; however, no responsibility is assumed for inaccuracies. Furthermore, this information does not convey to the purchaser of such devices any license under the patent rights to the manufacturer. CFSensor reserves the right to make changes without further notice to any product herein. CFSensor makes no warranty, representation or guarantee regarding the suitability of its product for any particular purpose, nor does CFSensor assume any liability arising out of the application or use of any product or circuit and specifically disclaims any and all liability, including without limitation consequential or incidental damages. Typical parameters can and do vary in different applications. All operating parameters must be validated for each customer application by customer's technical experts. CFSensor does not convey any license under its patent rights nor the rights of others.

【 CONTACT 】

CFSensor

14-15F/4Bldg High-Tech Park High-Tech Area Wuhu P.R.C.241000

Tel/Fax: +86 18226771331 Email: INFO@CFSensor.com

North America || Europe || Southeast Asia || Middle East || Latin America